

Portable DVD Player



Owner's Manual

Model: DP170

Before connecting, operating or adjusting this product,
please read this instruction booklet carefully and
completely.

P/NO : MFL30593001

Safety Precautions



CAUTION
RISK OF ELECTRIC SHOCK
DO NOT OPEN



CAUTION: TO REDUCE THE RISK OF ELECTRIC SHOCK
DO NOT REMOVE COVER (OR BACK)
NO USER-SERVICEABLE PARTS INSIDE
REFER SERVICING TO QUALIFIED SERVICE PERSONNEL.



This lightning flash with arrowhead symbol within an equilateral triangle is intended to alert the user to the presence of uninsulated dangerous voltage within the product's enclosure that may be of sufficient magnitude to constitute a risk of electric shock to persons.



The exclamation point within an equilateral triangle is intended to alert the user to the presence of important operating and maintenance (servicing) instructions in the literature accompanying the product.

WARNING: TO PREVENT FIRE OR ELECTRIC SHOCK
HAZARD, DO NOT EXPOSE THIS PRODUCT TO RAIN
OR MOISTURE.

WARNING: Do not install this equipment in a confined space such as a bookcase or similar unit.

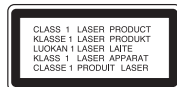

CAUTION: This product employs a Laser System.

To ensure proper use of this product, please read this owner's manual carefully and retain it for future reference. Should the unit require maintenance, contact an authorized service center.

Performing controls, adjustments, or carrying out procedures other than those specified herein may result in hazardous radiation exposure.

To prevent direct exposure to laser beam, do not try to open the enclosure. Visible laser radiation when open. **DO NOT STARE INTO BEAM.**

CAUTION: VISIBLE AND INVISIBLE LASER RADIATION WHEN OPEN AND INTERLOCKS DEFEATED.

CAUTION: The apparatus should not be exposed to water (dripping or splashing) and no objects filled with liquids, such as vases, should be placed on the apparatus.

SERIAL NUMBER: The serial number is found on the back of this unit.

This number is for this unit only. You should record the serial number in the space provided and retain this guide as a permanent record of your purchase.

Model No. _____

Serial No. _____

Safety Precautions (Continued)

CAUTION concerning the Power Cord

Most appliances recommend they be placed upon a dedicated circuit;

That is, a single outlet circuit which powers only that appliance and has no additional outlets or branch circuits. Check the specification page of this owner's manual to be certain.

Do not overload wall outlets. Overloaded wall outlets, loose or damaged wall outlets, extension cords, frayed power cords, or damaged or cracked wire insulation are dangerous. Any of these conditions could result in electric shock or fire. Periodically examine the cord of your appliance, and if its appearance indicates damage or deterioration, unplug it, discontinue use of the appliance, and have the cord replaced with an exact replacement part by an authorized servicer.

Protect the power cord from physical or mechanical abuse, such as being twisted, kinked, pinched, closed in a door, or walked upon. Pay particular attention to plugs, wall outlets, and the point where the cord exits the appliance.

To disconnect power from the mains, pull out the mains cord plug. When installing the product, ensure that the plug is easily accessible.

- The appliance is not intended for use by young children or infirm persons without supervision.
- Young Children should be supervised to ensure that they do not play with appliance.
- If the appliance is supplied from a cord extension set or an electrical portable outlet device, the cord extension set on electrical portable outlet device must be positioned so that it is not subject to splashing or ingress of moisture.

Before Use

To ensure proper use of this product, please read this owner's manual carefully and retain for future reference.

This manual provides information on the operation and maintenance of your DVD player. Should the unit require service, contact an authorized service location.

Symbol Used in this Manual

Note

Indicates special notes and operating features.

Tip

Indicates tips and hints for making the task easier. A section whose title has one of the following symbols is applicable only to the disc represented by the symbol.

- DVD** DVD discs
- VCD** Video CDs
- CD** Audio CDs
- MP3** MP3 discs
- WMA** WMA discs
- JPEG** JPEG discs

About the Symbol Display

" " may appear on your LCD display during operation and indicates that the function explained in this owner's manual is not available on that specific DVD video disc.

Notes on Discs

Handling Discs

Do not touch the playback side of the disc. Hold the disc by the edges so that fingerprints do not get on the surface. Never stick paper or tape on the disc.

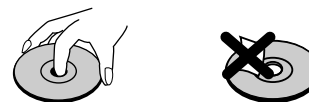

Storing Discs

After playing, store the disc in its case. Do not expose the disc to direct sunlight or sources of heat and never leave it in a parked car exposed to direct sunlight.

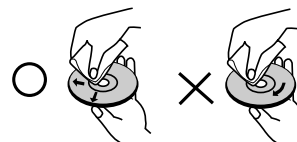

Cleaning Discs

Fingerprints and dust on the disc can cause poor picture quality and sound distortion. Before playing, clean the disc with a clean cloth. Wipe the disc from the center out.



Before Use (Continued)

Types of Playable Discs

	DVD (8 cm / 12 cm disc)
	Video CD (VCD) (8 cm / 12 cm disc)
	Audio CD (8 cm / 12 cm disc)

In addition, this unit plays DVD±R, DVD±RW, SVCD and CD-R or CD-RW that contains audio titles, MP3, WMA or JPEG files.



Manufactured under license from Dolby Laboratories. “Dolby”, “Pro Logic”, and the double-D symbol are trademarks of Dolby Laboratories.

DTS and DTS Digital Out are trademarks of Digital Theater Systems, Inc.

Notes

- Depending on the conditions of the recording equipment or the CD-R/RW (or DVD±R/±RW) disc itself, some CD-R/RW (or DVD±R/±RW) discs cannot be played on the unit.
- Do not attach any seal or label to either side (the labeled side or the recorded side) of a disc.
- Do not use irregularly shaped CDs (e.g., heart-shaped or octagonal). It may result in malfunctions.

Notes on DVDs

Some playback operations of DVDs may be intentionally programmed by software manufacturers. This unit plays DVDs according to disc content designed by the software manufacturer, therefore some playback features may not be available or other functions may be added.

Regional Code

This unit has a regional code printed on the bottom of the unit. This unit can play only DVD discs labeled same as the bottom of the unit or “ALL”.

Notes on Regional Codes

- Most DVD discs have a globe with one or more numbers in it clearly visible on the cover. This number must match your unit’s regional code or the disc cannot play.
- If you try to play a DVD with a different regional code from your player, the message “Check Regional Code” appears on the TV screen.

Table of Contents

Introduction

Safety Precautions	2-3
Before Use	4-5
Symbol used in this Manual	4
About the  Symbol Display	4
Notes on Discs	4
Types of Playable Discs	5
Table of Contents	6
Identification of Controls	7-10
Main Unit	7-8
Remote Control	9-10

Preparation

Power Connection	11-14
AC Adapter	11
Automotive Adapter	12
Battery Pack	13-15
Audio/video Connection	16
Rotate the LCD	17
Initial Settings	18-23
General Operation	18
LANGUAGE	18
DISPLAY	19
AUDIO	20
LOCK (Parental Control)	21-22
OTHERS	23

Operation

General Feature	24-26
On-Screen Display	24
• Moving to another CHAPTER/TRACK	24
• Slow Motion	24
• Title Menu	24
• Disc Menu	24
• Changing the Audio Language	24
• Search	25

• Still Picture and Frame-by-Frame Playback	25
• Marker Search	25
• Repeat	25
• Repeat A-B	26
• Zoom	26
• Camera Angle	26
• Subtitles	26
• Changing the Audio channel	26
• Last Scene Memory	26
• Screen Saver	26
Playing an Audio CD and MP3/WMA Disc	27-29
Audio CD and MP3/WMA Disc Features	28
• Pause	28
• Moving to another Track	28
• Repeat Track/ All/ Normal	28
• Repeat A-B	28
• Search	28
Viewing a JPEG disc	29
Using this DVD Player you can view discs with JPEG files.	29
• Moving to another File	29
• To rotate picture	29
• Still Picture	29
• Zoom	29
JPEG compatibility with this player is limited as follows	29
Programmed Playback	30
• Erasing a Track from program list	30

Reference

Maintenance and Service	31
Language Code List	32
Area Code List	33
Troubleshooting	34
Specifications	35

Identification of Controls

Main Unit

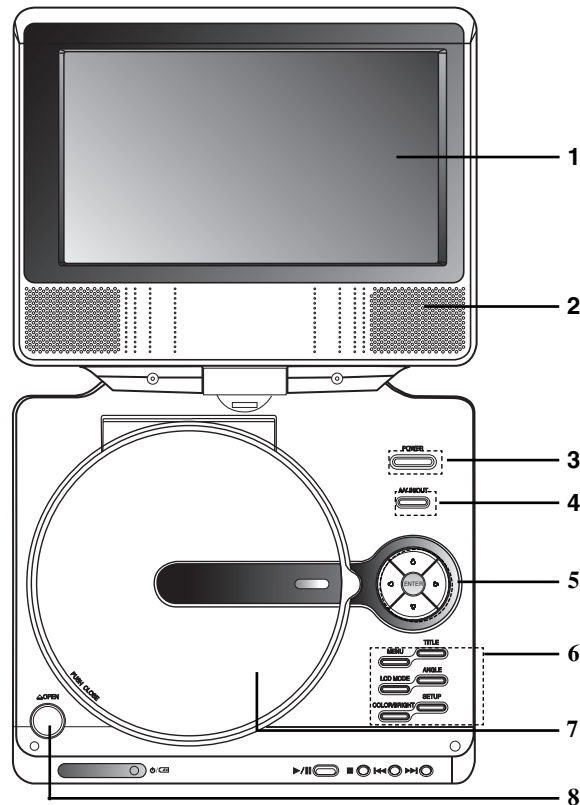

1. LCD screen
2. Speaker
3. Power ON/OFF : Switches the player ON and OFF.
4. A/V IN/OUT : Selects the source.
5. • ◀ ▶ ▲ ▼ (left/right/up/down)
Selects an item in the menu.
• ◀ ▶ : Adjusts the COLOR/BRIGHT.
• ENTER : Confirms menu selection.
6. • COLOR/BRIGHT : Selects the mode of LCD adjustment
Brightness → Color → OFF
• SETUP : Accesses or removes setup menu.
• TITLE : Displays title menu, if available.
• MENU : Accesses menu on a DVD disc.
• ANGLE : Selects a DVD camera angle, if available.
• LCD MODE : FULL → NORMAL → OFF
7. Disc Lid
8. OPEN button : Push this button to open the Disc lid.

Note

Place a disc with the playback side down on the spindle, and push gently on the center of the disc so it goes into position.

Identification of Controls (Continued)

Main Unit

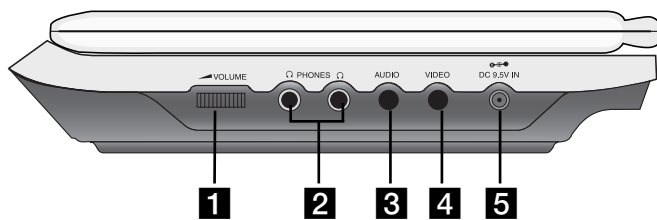

- 1** Volume Control
- 2** Earphone jack
- 3** AUDIO In/Out jack (OPTICAL OUT)
- 4** VIDEO In/Out jack

Note

If the VIDEO IN signal is not connected in AV IN mode, this unit will automatically power off in 10 minutes to prevent battery discharge.

- 5** DC 9.5V IN
Connect the AC adapter.

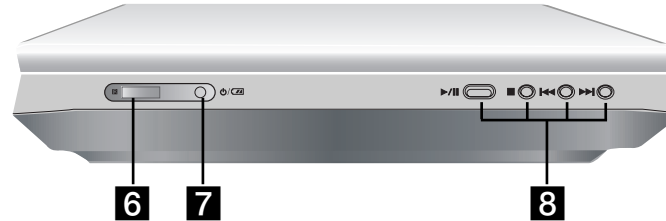

- 6** Remote sensor
Receive the signal from the Remote Control for operation.
 - 7** Battery charge indicator
Light turns red when the battery is in charging; turns green when the battery is fully charged.
 - 8**
 - **PLAY (▶/||)**: Starts playback/ Pauses playback temporarily.
 - **STOP (■)**: Stops playback.
 - **Reverse SKIP/SEARCH (◀◀)**
Search backward*/ go to beginning of current chapter or track or go to previous chapter or track.
 - **Forward SKIP/SEARCH (▶▶)**
Search forward*/ go to next chapter or track.
- * Press and hold button for about two seconds.

Identification of Controls (Continued)

Remote Control

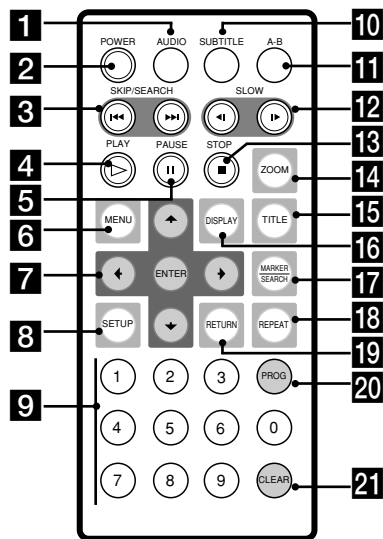

- 1 AUDIO**
Selects an audio language (DVD).
- 2 POWER**
Switches DVD Player ON and OFF.
- 3**
 - **Reverse SKIP/SEARCH (◀◀)**
Search backward*/ go to beginning of current chapter or track or go to previous chapter or track.
 - **Forward SKIP/SEARCH (▶▶)**
Search forward*/ go to next chapter or track.

* Press and hold button for about two seconds.
- 4 PLAY**
Starts playback.
- 5 PAUSE**
Pauses playback temporarily/ press repeatedly for frame-by-frame playback.
- 6 MENU**
Accesses menu on a DVD disc.
- 7**
 - **◀ ▶ ▲ ▼ (left/right/up/down)**
Selects an item in the menu.
 - **ENTER**
Confirms menu selection.
- 8 SETUP**
Accesses or removes setup menu.
- 9 0-9 number buttons**
Selects numbered items in a menu.
- 10 SUBTITLE**
Selects a subtitle language.
- 11 A-B**
Repeat sequence.
- 12 SLOW (◀|▶)**
Reverse/ Forward slow playback.
- 13 STOP (■)**
Stops playback.
- 14 ZOOM**
Enlarges video image.
- 15 TITLE**
Displays title menu, if available.
- 16 DISPLAY**
Accesses On-Screen display.
- 17**
 - **MARKER**
Marks any point during playback.
 - **SEARCH**
Displays MARKER SEARCH menu.
- 18 REPEAT**
Repeat chapter, track, title all.
- 19 RETURN**
Removes the setup menu.
- 20 PROG.**
Places a track on the program list.
- 21 CLEAR**
Removes a track number on the program list or a mark on the MARKER SEARCH menu.

Identification of Controls (Continued)

Insert the battery (Lithium battery)

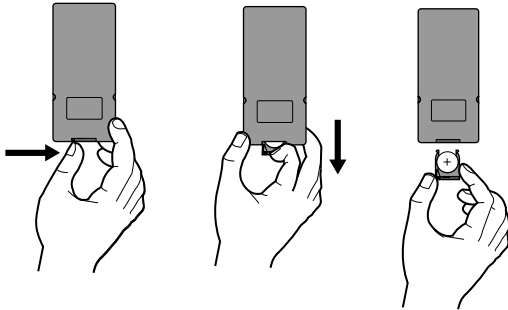

Notes

- Do not expose the Remote Control sensor to bright light.
- Do not place obstacles between the Remote Control sensor and the Remote Control.

■ Replacing the button-type battery

The battery normally lasts for about a year. Replace the battery if the Remote Control fails to operate the unit when used within the operation range.

Button-type battery (Lithium battery)

1. Pinch the battery holder clip together then pull the tab to remove the battery holder.
2. Insert the battery with the + facing in the same direction as the + on the battery holder.
3. Replace the battery holder with battery into the Remote Control unit making sure that it is fully inserted.

- Replace Remote Control unit battery with 3V micro lithium cells such as CR. 2025 or its equivalent.
- Dispose of battery safely in accordance with local laws. Do not dispose of in fire.

Warning: The battery used in this device may present a fire or chemical burn hazard if mistreated. Do not recharge, disassemble, incinerate, or heat above 100 °C (212 °F). Replace the battery with Matsushita Elec. Ind. Co., Ltd. (Panasonic), part no. CR. 2025 only. Use of another battery may present a risk of fire or explosion. Dispose of used batteries. Keep batteries away from children. Do not disassemble or dispose of in fire.

Power Connection

AC Adapter

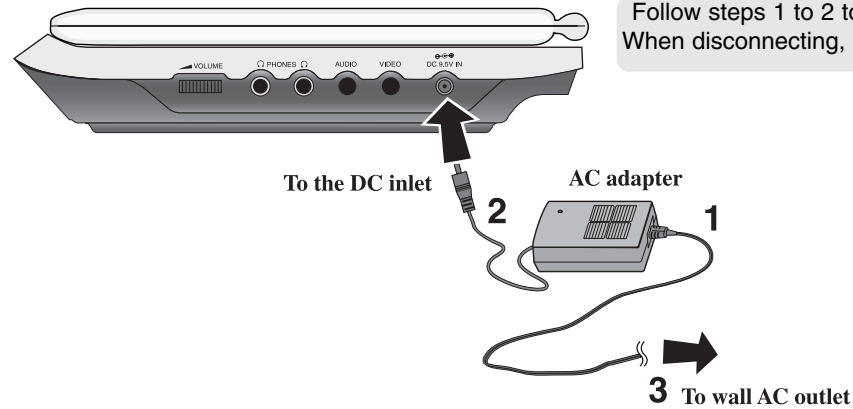

Follow steps 1 to 2 to connect.
When disconnecting, reverse the order.

Preparation

Caution

- Do not connect the power plug to a power outlet other than that indicated on the label, as this can result in a risk of fire or electric shock.
- Do not connect or disconnect the power plug with wet hands. Doing so may cause electric shock.
- Do not use an AC adapter other than one specified, as it can cause a fire or damage to the player.

AC adapter

- This AC adapter operates on 100-240V~ 2.2A 50-60Hz.
- MODEL NO. : DP-AC90
- Manufactured by WANLIDA GROUP Co., Ltd.
- Contact an electrical parts distributor for assistance in selecting a suitable AC plug adapter or AC cord set.

Power Connection (Continued)

Automotive Adapter

This DVD player and its automotive adapter are designed for use in vehicles that have 12 volt, negative ground electrical systems. (This is standard for most vehicles.) If your vehicle has a different type of electrical system, the DC power system cannot be used.

Follow steps 1 to 2 to connect.
When disconnecting, reverse the order.

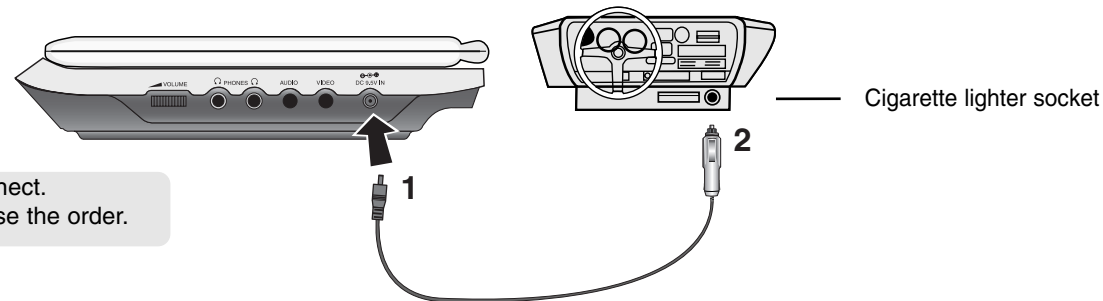

Caution

- To prevent electrical shock and possible damage to your DVD player or vehicle, always unplug the automotive adapter from the cigarette lighter socket before you remove the plug from your DVD player.
- A 3 amp, 250V fuse for protection is installed in the automotive adapter.
- While the engine is being started, disconnect the automotive adapter from the car's cigarette lighter socket.
- Do not operate your DVD player when the car battery is discharged. Peak current from the car generator may cause the DC fuse to blow.
- If the vehicle's supply voltage drops below approximately 10 volts, your DVD player may not work properly.

- Do not leave your DVD player in a place where the temperature exceeds 70°C (158°F), or the pick-up device may be damaged.

Examples include:

- Inside a car with the windows closed and in direct sunshine.
- Near a heating appliance.

Automotive adapter

- This automotive adapter operates on DC 12V.
- MODEL NO. : DPDC1
- Manufactured by WANLIDA Digital Technology Co., Ltd.
- Contact an electrical parts distributor for assistance in selecting a suitable automotive adapter.

Power Connection (Continued)

Battery Pack

- Charge the battery pack before using it for the first time.
- **Attaching the battery pack (supplied)**
1. Match the hooks of the battery pack into the holes on the bottom of the player.
 2. Press and slide the battery pack until the hooks click.

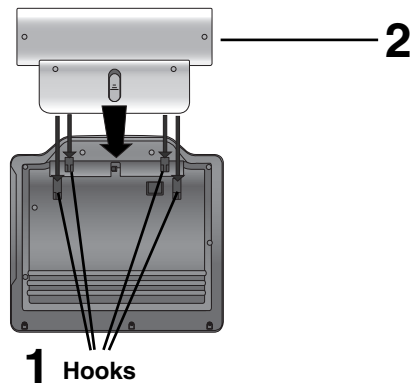

Notes

- Do not detach the battery pack during playback.
- Be careful not to drop the battery pack.

■ **Detaching the battery pack**

1. Press the **RELEASE** knob.
2. Pull the battery pack until the hooks click.

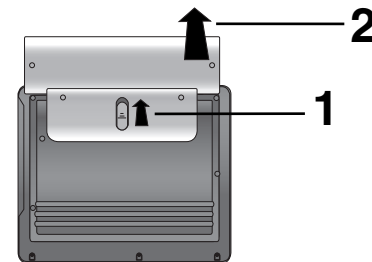

ATTENTION

The product that you have purchased contains a rechargeable battery. The battery is recyclable. At the end of its useful life, under various state and local laws, it may be illegal to dispose of this battery into the municipal waste stream. Check with your local solid waste/officials for details in your area for recycling options or proper disposal.

Power Connection (Continued)

■ Charging the battery pack

1. Attach the battery pack to the player.
2. Connect the AC adapter to the player and then plug into an AC outlet.

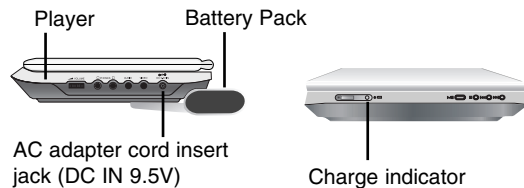

When charging starts, the charge indicator lights up in red.

3. When recharging is complete, the indicator turns up in green.
4. Disconnect the AC adapter from the player and pull out the plug from the AC outlet after charging.

■ **If there is not enough battery, “” flashes on the LCD screen**

■ Recharging and play times

Recharging with player	Play time (DVD-VIDEO) LCD On
Approx. 2.5 hours	Approx. 3 hours*

- * When Brightness control is set to minimum.
- using the headphones.
 - at room temperature (25°C)

Notes

- Recharging times shown above depend on operating conditions.
- When the power is ON, you cannot charge the battery.
- Charge the battery at a temperature of +5°C (+41°F) to +35°C (+95°F).
The charging time may vary, depending on the surrounding temperature.
- The battery will not be charged when it is naturally or purposely discharged. Because the unit cannot perceive battery voltage, even if you attached the battery.
When you are in this situation, power on the unit and then power off again. Then battery charging will proceed.

Audio/Video Connection

The picture and sound of a nearby TV, VCR, or radio may be distorted during playback. If this occurs, position the player away from the TV, VCR, or radio, or turn off the unit after removing the disc.

DVD Player Connections

Depending on your TV and other equipment there are various ways you can connect the player. Please refer to the manuals of your TV, stereo system or other devices as necessary for additional connection information.

Video and Audio Connections to Your TV

Make sure the DVD player is connected directly to the TV and not to a VCR, otherwise the DVD image could be distorted by the copy protection system.

Video:

Connect the VIDEO jack on the DVD player to the video in jack on the TV using the video cable.

Audio Connection to Your TV:

Connect the AUDIO jacks of the DVD Player to the audio left and right IN jacks on the TV using the audio cables. Do not connect the DVD Player's AUDIO OUT jack to the phone in jack (record deck) of your audio system.

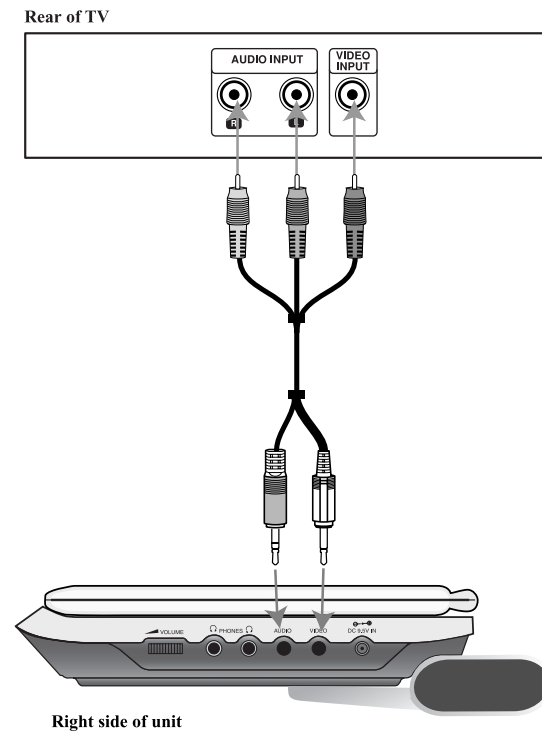

Preparation

You must set the A/V IN/OUT switch to the "A/V OUT" mode

Audio/Video Connection

Audio Connection to Optional Equipment

Connect the DVD player to your optional equipment for audio output.

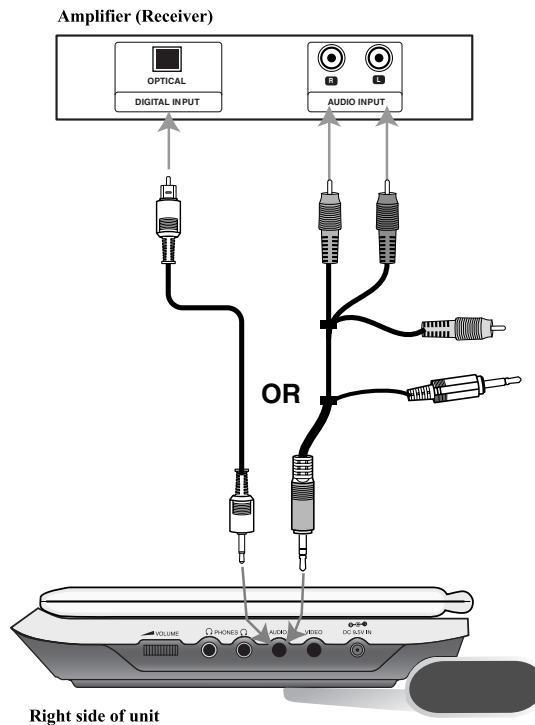

Amplifier equipped with 2-channel analog stereo or Dolby Pro Logic II / Pro Logic: Connect the AUDIO OUT jacks on the DVD player to the audio left and right IN jacks on your amplifier, receiver, or stereo system, using the audio cables.

Amplifier equipped with 2-channel digital stereo (PCM) or audio / video receiver equipped with a multi-channel decoder (Dolby Digital™, MPEG 2, or DTS): Connect one of the DVD Player's DIGITAL AUDIO OUT jack to the corresponding in jack on your amplifier. Use an optional digital audio cable.

Digital Multi-channel sound

A digital multi-channel connection provides the best sound quality. For this you need a multi-channel audio / video receiver that supports one or more of the audio formats supported by your DVD player such as MPEG 2, Dolby Digital and DTS. Check the receiver manual and the logos on the front of the receiver.

Notes

- If the audio format of the digital output does not match the capabilities of your receiver, the receiver produces a strong, distorted sound or no sound at all.
- Six Channel Digital Surround Sound via a digital connection can only be obtained if your receiver is equipped with a Digital Multi-channel decoder.
- To see the audio format of the current DVD in the on-screen display, press AUDIO.

Rotate the LCD

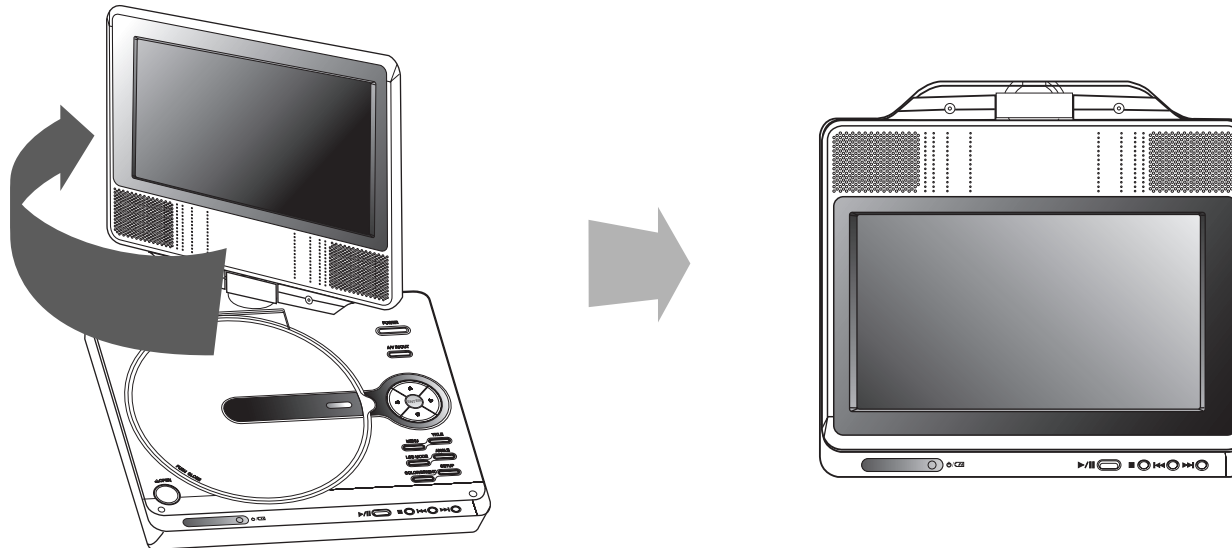

You can rotate LCD clockwise an angle of 180 degrees. However, if you turn it by force, it can cause serious damage.

After rotating LCD completely, you can fold the LCD screen as shown above.

Preparation

Initial Setting

By using the Setup menu, you can make various adjustments to items such as picture and sound. You can also set a language for the subtitles and the Setup menu, among other things. For details on each Setup menu item, see pages 18 to 23.

To display and exit the Menu:

Press SETUP to display the menu. A second press of SETUP will take you back to initial screen.

To go to the next level:

Press ► on the Remote Control.

To go back to the previous level:

Press ◀ on the Remote Control.

General Operation

1. Press SETUP. The Setup menu appears.
2. Use ◀ / ► to select the desired option then press ▼ or ENTER to move to the second level. The screen shows the current setting for the selected item, as well as alternate setting(s).
3. Use ▲ / ▼ to select the second desired option then press ► to move to the third level.
4. Use ▲ / ▼ to select the desired setting then press ENTER to confirm your selection. Some items require additional steps.
5. Press SETUP, RETURN or PLAY to exit the Setup menu.

LANGUAGE

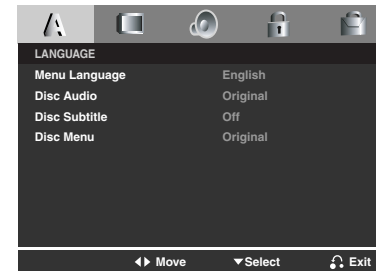

Menu Language

Select a language for the Setup menu and on-screen display.

Disc Audio / Subtitle / Menu **DVD**

Select the language you prefer for the audio track (disc audio), subtitles, and the disc menu.

Original: Refers to the original language in which the disc was recorded.

Other: To select another language, press number buttons then Press ENTER to enter the corresponding 4-digit number according to the language code list in the reference chapter. If you enter the wrong language code, press CLEAR.

Initial Setting (Continued)

DISPLAY

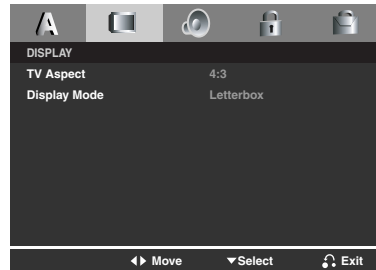

TV Aspect **DVD**

4:3: Select when a standard 4:3 TV is connected.

16:9: Select when a 16:9 wide TV is connected.

Display Mode **DVD**

Display Mode setting works only when the TV Aspect mode is set to "4:3".

LetterBox: Displays a wide picture with bands on the upper and lower portions of the screen.

Panscan: Automatically displays the wide picture on the entire screen and cuts off the portions that do not fit.

Initial Setting (Continued)

AUDIO

Each DVD disc has a variety of audio output options. Set the player's AUDIO options according to the type of audio system you use.

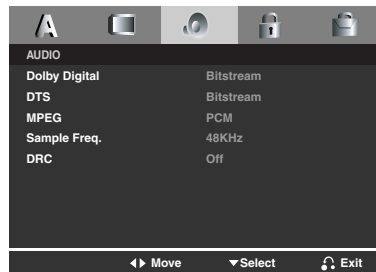

Dolby Digital / DTS / MPEG **DVD**

Bitstream: Select "Bitstream" if you connect the DVD Player's DIGITAL OUT jack to an amplifier or other equipment with a Dolby Digital, DTS or MPEG decoder.

PCM (for Dolby Digital / MPEG): Select when connected to a two-channel digital stereo amplifier. DVDs encoded in Dolby Digital or MPEG will be automatically downmixed to two-channel PCM audio.

Off (for DTS): If you select "Off", the DTS signal is not output through the DIGITAL OUT jack.

Sample Freq. (Frequency) **DVD**

If your receiver or amplifier is NOT capable of handling 96 KHz signals, select 48 KHz. When this choice is made, this unit automatically converts any 96 KHz signals to 48 KHz so your system can decode them.

If your receiver or amplifier is capable of handling 96 KHz signals, select 96 KHz. When this choice is made, this unit passes each type of signal through without any further processing.

Check the documentation for your amplifier to verify its capabilities.

DRC (Dynamic Range Control) **DVD**

With the DVD format, you can hear a program's soundtrack in the most accurate and realistic presentation possible, thanks to digital audio technology. However, you may wish to compress the dynamic range of the audio output (the difference between the loudest sounds and the quietest ones). This allows you to listen to a movie at a lower volume without losing clarity of sound. Set DRC to On for this effect.

Initial Setting (Continued)

LOCK (Parental Control)

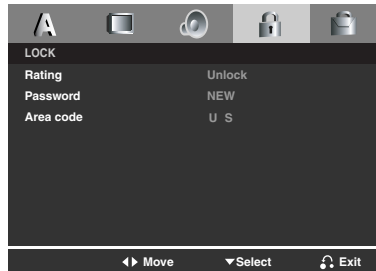

Rating **DVD**

Some movies contain scenes that may not be suitable for children to view. Many of these discs contain parental control information that applies to the complete disc or to certain scenes on the disc. Movies and scenes are rated from 1 to 8, depending on the country. Some discs offer more suitable scenes as an alternative.

The parental control feature allows you to block access to scenes below the rating you input, thereby preventing your children from being able to view material you believe is unsuitable.

Rating 1-8: Rating one (1) has the most restrictions and rating eight (8) is the least restrictive.

Unlock: If you select unlock, parental control is not active and the disc plays in full.

Note

If you set a rating for the player, all disc scenes with the same rating or lower are played. Higher rated scenes are not played unless an alternate scene is available on the disc. The alternative must have the same rating or a lower one. If no suitable alternative is found, playback stops. You must enter the 4-digit password or change the rating level in order to play the disc.

1. Select Rating on the LOCK menu then press ►.
2. Select a rating from 1 to 8 using the ▲ / ▼ buttons and press . The password window will appear.
3. **If you have not entered password yet:**
When the "New Password" section is highlighted, enter a 4-digit password using the numbered buttons then press ENTER. Enter the 4-digit password again to verify when the "Confirm Password" section is highlighted. The "OK" will be highlighted.
If you have entered password already:
Enter a 4-digit password you have entered using the numbered buttons. The "OK" will be highlighted.
4. Press ENTER to confirm your rating selection, then press SETUP to exit the menu.

Tips

- If you make a mistake before pressing ENTER in each section, press CLEAR to enter again or ◀ repeatedly to delete password numbers one by one then correct it.
- If you enter the wrong password, you can not proceed to the next step.

Initial Setting (Continued)

Password

You can create or change password.

1. Select Password on the LOCK menu then press ►. The “Change” is highlighted
2. Press ENTER then the password window will appear.
3. **To make a new password:**
When the “New Password” section is highlighted, enter a 4-digit password using the numbered buttons then press ENTER. Enter the 4-digit password again to verify when the “Confirm Password” section is highlighted, then. The “OK” will be highlighted.

To change the password:

When the “Old Password” section is highlighted, enter the 4-digit password you have created then press ENTER. The “New Password” section will be highlighted. Enter a new 4-digit password using the numbered buttons then press ENTER. Enter the new 4-digit password again to verify when the “Confirm Password” section is highlighted. The “OK” will be highlighted.

4. Press SETUP to exit the menu.

If you forget your password

If you forget your password you can clear it using the following steps:

1. Remove any disc from the unit and close the disc tray.
2. Press SETUP and setup menu appears on the TV screen. Use the numbered buttons to enter the 6-digit number “210499”.
3. Enter a new password as described above.

Area Code **DVD**

Enter the code of the area whose standards were used to rate the DVD video disc, based on the list in the reference chapter.

1. Select “Area Code” on the LOCK menu then press ►.
2. Select the first character using ▲ / ▼ buttons.
3. Shift the cursor using ► button and select the second character using ▲ / ▼ buttons then press ENTER, the password window will appear.
4. Press ENTER, the password window will appear.
5. **If you have not entered password yet:**

When the “New Password” section is highlighted, enter a 4-digit password using the numbered buttons then press ENTER. Enter the 4-digit password again to verify when the “Confirm Password” section is highlighted. The “OK” will be highlighted.

If you have entered password already:

Enter a 4-digit password you have entered using the numbered buttons. The “OK” will be highlighted.

6. Press ENTER to confirm your Area Code selection, then press SETUP to exit the menu.

Initial Setting (Continued)

OTHERS

The Auto Play and PBC settings can be changed.

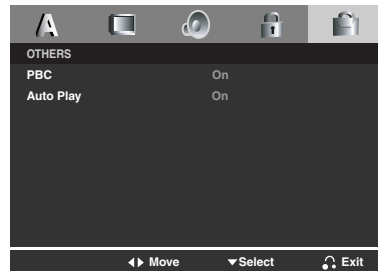

PBC **VCD**

Set Playback Control (PBC) to On or Off.

On: Video CDs with PBC are played according to the PBC.

Off: Video CDs with PBC are played the same way as Audio CDs.

Notes

- **PBC: Playback Control (Video CD only)**

Playback control is available for Video CD (VCD) version 2.0 disc formats. PBC allows you to interact with the system via menus, search functions, or other typical computer-like operations. Moreover, still pictures of high resolution can be played if they are included in the disc. Video CDs not equipped with PBC (Version 1.1) operate in the same way as audio CDs.

- Use the number buttons to select the track you want to view and press RETURN to return to the menu screen. Menu settings and operating procedures may differ. Follow the instructions on the each menu screen. You also may set PBC to Off.

Auto Play **DVD**

You can set up the DVD Player so a DVD disc automatically starts playing whenever the DVD is inserted.

If Auto Play mode is set to On, this DVD player will search for title that has the longest playback time and then play back the title automatically.

On: Auto Play function is activated.

Off: Auto Play function is not activated.

Note



The Auto Play function may not work for some DVDs.

General Feature

On-Screen Display **DVD**

Some items can be changed using the menu.

1. Press DISPLAY during playback.
2. Press ◀/▶ to select an item.
The selected item is highlighted.
3. Press ▲/▼ to change the setting.
Press ENTER.
You can also use the number buttons if appropriate (e.g. inputting the title number).

 02/04 : Title Number,  0:08:20 : Time search

 02/04 : Chapter Number (DVD disc only)

Moving to another CHAPTER **DVD** **VCD**

When a title on a disc has more than one chapter, you can move to another chapter as follows:

Press SKIP ◀◀ or ▶▶ briefly during playback to select the next chapter or to return to the beginning of the current chapter.
Press SKIP ◀◀ twice briefly to step back to the previous chapter.

Slow Motion **DVD** **VCD**

1. Press SLOW ◀◀ or ▶▶ during playback.
The player will enter SLOW mode.
2. Use the SLOW ◀◀ or ▶▶ to select the required speed:
◀◀ 1/16, ◀◀ 1/8, ◀◀ 1/4 or ◀◀ 1/2 (backward), or
▶▶ 1/16, ▶▶ 1/8, ▶▶ 1/4 or ▶▶ 1/2 (forward).
3. To exit slow motion mode, press PLAY.

Title Menu **DVD**

Checking the contents of DVD discs: Menus

DVDs may offer menus that allow you to access special features. To use the disc menu, press TITLE.
Input the corresponding number or use the ◀ ▶ ▲ ▼ buttons to highlight your selection. Then press ENTER.

Disc Menu **DVD**

Press MENU and the disc menu is displayed.
Press MENU again to exit.

Changing the Audio Language **DVD**

Press AUDIO repeatedly during playback to hear a different audio language or audio track.

General Feature

Search **DVD** **VCD**

1. Press and hold SKIP/SEARCH **I◀◀** or **▶▶I** for about two seconds during playback.
The player will now go into SEARCH mode.
2. Press and hold SKIP/SEARCH **I◀◀** or **▶▶I** repeatedly to select the required speed: **◀◀X2**, **◀◀X4**, **◀◀X16**, **◀◀X100** (backward) or **▶▶X2**, **▶▶X4**, **▶▶X16**, **▶▶X100** (forward).
With a Video CD, the Search speed changes: **◀◀X2**, **◀◀X4**, **◀◀X8**, (backward) or **▶▶X2**, **▶▶X4**, **▶▶X8**, (forward).
3. To exit SEARCH mode, press PLAY.

Still Picture and Frame-by-Frame Playback **DVD** **VCD**

Press PAUSE on the Remote Control during playback. Advance the picture frame-by-frame by pressing PAUSE repeatedly. Press PLAY to exit still motion mode.

Marker Search **DVD** **VCD**

Storing a MARKER in the DVD memory is similar to marking your page in a book. It allows you to quickly return to any point on the disc.

Storing a marker in the memory

1. Press MARKER/SEARCH during play.
The MARKER SEARCH menu appears on the screen.
2. During playback, press ENTER when playback reaches the spot that you want to memorize.
3. Repeat step 2 to enter up to nine Marker points on a disc.
4. To remove the MARKER SEARCH menu, press MARKER/SEARCH.

To Recall or Clear a Marked Scene

1. Press MARKER/SEARCH during playback.
The MARKER SEARCH menu will appear on the screen.
2. Press **◀▶** to select the marker to be recalled/ cleared.
3. Press ENTER to recall a marker.
Press CLEAR to clear a marker.
Play resumes from the point corresponding to the selected marker, or the selected marker is cleared.

Repeat **DVD** **VCD**

Press REPEAT during playback to select a desired repeat mode.

DVD Video Discs

- Chapter: repeats the current chapter.
- Title: repeats the current title.
- Off: does not play repeatedly.

Video CDs

- Track : repeats the current track
- All : repeats all the tracks on a disc.
- Off : does not play repeatedly.

Note

If you press SKIP (**▶▶I**) once during Repeat Chapter playback, the repeat playback cancels.

General Feature

Repeat A-B **DVD** **VCD**

To repeat a sequence.

1. Press A-B at your chosen starting point. "A" appears briefly on the TV screen.
2. Press A-B again at your chosen end point. "A B" appears briefly on the TV screen and the repeat sequence begins.
3. Press A-B again to cancel.

Zoom **DVD** **VCD**

Use zoom to enlarge the video image.

1. Press ZOOM during playback to activate the Zoom function.
2. Each press of the ZOOM button changes the screen in the sequence: 200% → 300% → 400% → Normal (4 steps).
- 3 Use the ◀ ▶ ▲ ▼ buttons to move through the zoomed picture.
4. To resume normal playback, press CLEAR.

Note

Zoom may not work on some DVDs.

Camera Angle **DVD**

If the disc contains scenes recorded at different camera angles, you can change to a different camera angle during playback.

Press ANGLE repeatedly during playback to select a desired angle.

Note that the number of the current angle appears on the display.

Subtitles **DVD**

Press SUBTITLE repeatedly during playback to display the different subtitle languages.

Last Scene Memory **DVD** **CD**

This player memorizes last scene from the last disc that is viewed. The last scene remains in memory even if you remove the disc from the player or switch off the player. If you load a disc that has the scene memorized, the scene is automatically recalled.

Note

This player does not memorize the scene of a disc if you switch off the player before commencing to play the disc.

Screen Saver

The screen saver appears when you leave the DVD player in Stop mode for about five minutes. If the Screen Saver is displayed for five minutes, the DVD Player automatically turns itself off.

Playing an Audio CD or MP3/WMA Disc

Audio CD

Once you insert an audio CD a menu appears on the TV screen. Press ▲ / ▼ to select a track then press PLAY or ENTER to playback starts.



MP3 / WMA

1. Press ▲ / ▼ to select a folder, and press PLAY or ENTER to see the folder contents.
2. Press ▲ / ▼ to select a track then press PLAY or ENTER. Playback starts.

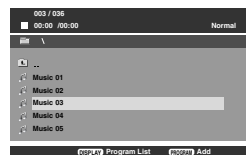

Tips

- If you are in a file list on the MUSIC menu and want to return to the Folder list, use the ▲ / ▼ to highlight  and press PLAY or ENTER.
- Press DVD MENU to move to the next page. Press TITLE to move to the previous page.
- On a CD with MP3/WMA and JPEG you can switch MP3/WMA and JPEG. Press ▲ / ▼ to select a folder, and press ENTER to see the folder contents.

MP3 / WMA disc compatibility with this player is limited as follows:

- Sampling frequency: within 8 - 48 kHz (MP3), within 32 - 48kHz (WMA)
- Bit rate: within 8 - 320kbps (MP3), 32 - 192kbps (WMA)
- The player cannot read an MP3/WMA file that has a file extension other than “.mp3” / “.wma”.
- CD-R physical format should be ISO 9660
- If you record MP3 / WMA files using software that cannot create a file system (eg. Direct-CD) it is impossible to playback MP3 / WMA files. We recommend that you use Easy-CD Creator, which creates an ISO 9660 file system.
- File names should have a maximum of 8 letters and must incorporate an .mp3 or .wma extension.
- They should not contain special letters such as / ? * : “ < > | etc.
- The total number of files on the disc should be less than 648.

This DVD player requires discs and recordings to meet certain technical standards in order to achieve optimal playback quality. Pre-recorded DVDs are automatically set to these standards. There are many different types of recordable disc formats (including CD-R containing MP3 or WMA files) and these require certain pre-existing conditions (see above) to ensure compatible playback.

Customers should note that permission is required in order to download MP3 / WMA files and music from the Internet. Our company has no right to grant such permission. Permission should always be sought from the copyright owner.

Playing an Audio CD or MP3/WMA Disc

Audio CD and MP3 / WMA Disc Features

Pause **CD** **MP3** **WMA**

1. Press PAUSE during playback.
2. To return to playback, press PLAY, ENTER or press PAUSE again.

Moving to another Track **CD** **MP3** **WMA**

1. Press SKIP (I◀◀ or ▶▶I) briefly during playback to go to the next track or to return to the beginning of the current track.
2. Press SKIP I◀◀ twice briefly to go back to the previous track.
3. You can play any track by inputting its number.

Repeat Track/All/Normal **CD** **MP3** **WMA**

You can play a track/all on a disc.

1. Press REPEAT when playing a disc. The repeat icon appears.
2. Press REPEAT to select a desired repeat mode.
 - Track: repeats the current track
 - All: repeats all the tracks on a disc.
 - Normal: does not play repeatedly.

Note

If you press SKIP (▶▶I) once during Repeat Track playback, the repeat playback cancels.

Repeat A-B **CD** **MP3** **WMA**

1. To repeat a sequence during disc playback press A-B at your chosen starting point. The Repeat icon and "A" appear on the menu screen.
2. Press A-B again at your chosen end point. The Repeat icon and "A B" appear on the menu screen, and the sequence begins to play repeatedly.
3. To exit the sequence and return to normal play, press A-B again.

Search **CD** **MP3** **WMA**

1. Press and hold SKIP/SEARCH (I◀◀ or ▶▶I) for about two seconds during playback. The player will now go into SEARCH mode.
2. Press and hold SKIP/SEARCH (I◀◀ or ▶▶I) repeatedly to select the required speed: ◀◀X2, ◀◀X4, ◀◀X8 (backward) or ▶▶X2, ▶▶X4, ▶▶X8 (forward). Search speed and direction are indicated on the menu screen.
3. To exit SEARCH mode, press PLAY.

Viewing a JPEG Disc

Using this DVD Player you can view discs with JPEG files.

1. Insert a disc and close the tray.
The PHOTO menu appears on the TV screen.

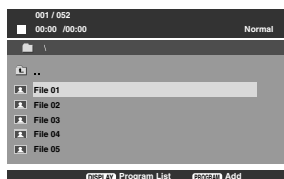

2. Press ▲ / ▼ to select a folder, and press ENTER or PLAY. A list of files in the folder appears. If you are in a file list and want to return to the previous Folder list, use the ▲ / ▼ buttons on the remote to highlight and press ENTER or PLAY.
3. If you want to view a particular file, press ▲ / ▼ to highlight a file and press ENTER or PLAY. Viewing the file proceeding starts. While viewing a picture, you can press STOP to move to the previous menu (PHOTO menu).

Tips

- Press DVD MENU to move to the next page.
Press TITLE to move to the previous page.
- On a CD with MP3/WMA and JPEG you can switch MP3/WMA and JPEG. Press ▲ / ▼ to select a folder, and press ENTER to see the folder contents.

Moving to another File **JPEG**

Press SKIP (◀◀ or ▶▶) once while viewing a picture to advance to the next or previous file.

To rotate picture

Press ◀ / ▶ during showing a picture to rotate the picture clockwise or counter clockwise.

Still Picture **JPEG**

1. Press PAUSE during slide show.
The player will now go into PAUSE mode.
2. To return to the slide show, press PLAY, ENTER or press PAUSE again.

Zoom **JPEG**

Use zoom to enlarge the video image.

1. Press ZOOM during playback to activate the Zoom function.
2. Each press of the ZOOM button changes the screen in the sequence: 100% → 150% → 200% → 100%
3. Use the ◀ ▶ ▲ ▼ buttons to move through the zoomed picture.
4. To resume normal playback, press CLEAR or press ZOOM repeatedly to select the 100%.

JPEG disc compatibility with this player is limited as follows:

- Depending upon the size and number of JPEG files, it could take a long time for the DVD player to read the disc's contents. If you don't see an on-screen display after several minutes, some of the files may be too large — reduce the resolution of the JPEG files to less than 2M pixels as 2760 x 2048 pixels and burn another disc.
- The total number of files and folders on the disc should be less than 648.
- Ensure that all the selected files have the “.jpg” extensions when copying into the CD layout.
- If the files have “.jpe” or “.jpeg” extensions, please rename them as “.jpg” file.
- File names without “.jpg” extension can not be read by this DVD player. Even though the files are shown as JPEG image files in Windows Explorer.

Programmed playback **CD** **MP3** **WMA**

The program function enables you to store your favorite tracks from any disc in the player memory. A program can contain 30 tracks (Audio CD, MP3/WMA).

1. Insert a disc. (Audio CD, MP3 or WMA.)
2. Press ▲ / ▼ to select the desired file.
3. Press PROGRAM during playback or in the stop mode. Repeat press PROGRAM to place additional tracks on the program list.
4. Press DISPLAY. Program List menu appear. Press ▲ / ▼ to select the track you want to start playing. Press DVD MENU to move to the next page. Press TITLE to move to the previous page.

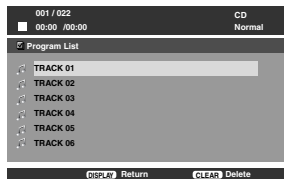

Audio CD Menu

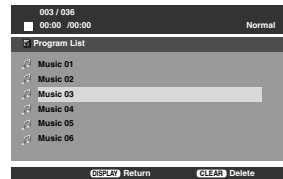

MP3/WMA Menu

Erasing a Track from program list

1. Use ▲ / ▼ to select the track that you wish to erase from the program list.
2. Press CLEAR. Repeat to erase additional tracks on the list.

For details on each operation item, refer to relevant page.

5. Press PLAY or ENTER to start.
6. To resume normal playback from programmed playback. Press DISPLAY then select a track of list and then press PLAY or ENTER.

Maintenance and Service

Refer to the information in this chapter before contacting a service technician.

Handling the Unit

When shipping the unit

Please save the original shipping carton and packing materials. If you need to ship the unit, for maximum protection, re-pack the unit as it was originally packed at the factory.

Keeping the exterior surfaces clean

- Do not use volatile liquids such as insecticide spray near the unit.
- Do not leave rubber or plastic products in contact with the unit for a long period of time. since they leave marks on the surface.

Cleaning the unit

To clean the player, use a soft, dry cloth. If the surfaces are extremely dirty, use a soft cloth lightly moistened with a mild detergent solution.

Do not use strong solvents such as alcohol, benzine, or thinner, as these might damage the surface of the unit.

Maintaining the Unit

The DVD player is a high-tech, precision device. If the optical pick-up lens and disc drive parts are dirty or worn, the picture quality could be diminished.

Depending on the operating environment, regular inspection and maintenance are recommended after every 1,000 hours of use.

For details, please contact your nearest authorized service center.

Language Code List

Language	Code	Language	Code	Language	Code	Language	Code
Abkhazian	6566	Fiji	7074	Lingala	7678	Singhalese	8373
Afar	6565	Finnish	7073	Lithuanian	7684	Slovak	8375
Afrikaans	6570	French	7082	Macedonian	7775	Slovenian	8376
Albanian	8381	Frisian	7089	Malagasy	7771	Somali	8379
Ameharic	6577	Galician	7176	Malay	7783	Spanish	6983
Arabic	6582	Georgian	7565	Malayalam	7776	Sudanese	8385
Armenian	7289	German	6869	Maltese	7784	Swahili	8387
Assamese	6583	Greek	6976	Maori	7773	Swedish	8386
Aymara	6588	Greenlandic	7576	Marathi	7782	Tagalog	8476
Azerbaijani	6590	Guarani	7178	Moldavian	7779	Tajik	8471
Bashkir	6665	Gujarati	7185	Mongolian	7778	Tamil	8465
Basque	6985	Hausa	7265	Nauru	7865	Tatar	8484
Bengali; Bangla	6678	Hebrew	7387	Nepali	7869	Telugu	8469
Bhutani	6890	Hindi	7273	Norwegian	7879	Thai	8472
Bihari	6672	Hungarian	7285	Oriya	7982	Tibetan	6679
Breton	6682	Icelandic	7383	Panjabi	8065	Tigrinya	8473
Bulgarian	6671	Indonesian	7378	Pashto, Pushto	8083	Tonga	8479
Burmese	7789	Interlingua	7365	Persian	7065	Turkish	8482
Byelorussian	6669	Irish	7165	Polish	8076	Turkmen	8475
Cambodian	7577	Italian	7384	Portuguese	8084	Twi	8487
Catalan	6765	Japanese	7465	Quechua	8185	Ukrainian	8575
Chinese	9072	Javanese	7487	Rhaeto-Romance	8277	Urdu	8582
Corsican	6779	Kannada	7578	Rumanian	8279	Uzbek	8590
Croatian	7282	Kashmiri	7583	Russian	8285	Vietnamese	8673
Czech	6783	Kazakh	7575	Samoan	8377	Volapük	8679
Danish	6865	Kirghiz	7589	Sanskrit	8365	Welsh	6789
Dutch	7876	Korean	7579	Scots Gaelic	7168	Wolof	8779
English	6978	Kurdish	7585	Serbian	8382	Xhosa	8872
Esperanto	6979	Laothian	7679	Serbo-Croatian	8372	Yiddish	7473
Estonian	6984	Latin	7665	Shona	8378	Yoruba	8979
Faroese	7079	Latvian, Lettish	7686	Sindhi	8368	Zulu	9085

Area Code List

Choose an area code from this list.

Area	Code	Area	Code	Area	Code	Area	Code
Afghanistan	AF	Ethiopia	ET	Malaysia	MY	Saudi Arabia	SA
Argentina	AR	Fiji	FJ	Maldives	MV	Senegal	SN
Australia	AU	Finland	FI	Mexico	MX	Singapore	SG
Austria	AT	France	FR	Monaco	MC	Slovak Republic	SK
Belgium	BE	Germany	DE	Mongolia	MN	Slovenia	SI
Bhutan	BT	Great Britain	GB	Morocco	MA	South Africa	ZA
Bolivia	BO	Greece	GR	Nepal	NP	South Korea	KR
Brazil	BR	Greenland	GL	Netherlands	NL	Spain	ES
Cambodia	KH	Heard and McDonald Islands	HM	Netherlands Antilles	AN	Sri Lanka	LK
Canada	CA	Hong Kong	HK	New Zealand	NZ	Sweden	SE
Chile	CL	Hungary	HU	Nigeria	NG	Switzerland	CH
China	CN	India	IN	Norway	NO	Taiwan	TW
Colombia	CO	Indonesia	ID	Oman	OM	Thailand	TH
Congo	CG	Israel	IL	Pakistan	PK	Turkey	TR
Costa Rica	CR	Italy	IT	Panama	PA	Uganda	UG
Croatia	HR	Jamaica	JM	Paraguay	PY	Ukraine	UA
Czech Republic	CZ	Japan	JP	Philippines	PH	United States	US
Denmark	DK	Kenya	KE	Poland	PL	Uruguay	UY
Ecuador	EC	Kuwait	KW	Portugal	PT	Uzbekistan	UZ
Egypt	EG	Libya	LY	Romania	RO	Vietnam	VN
El Salvador	SV	Luxembourg	LU	Russian Federation	RU	Zimbabwe	ZW

Reference

Troubleshooting

Symptom	Cause	Correction
No power.	• The power cord is disconnected.	• Plug the power cord into the wall outlet securely.
	• The battery is discharged.	• Recharge the battery.
No picture on the LCD or TV (including video from another unit).	• The video cable is not connected securely.	• Connect the video cable into the jacks securely.
	• The AV IN/DVD switch is not set correctly.	• Set the AV IN/DVD switch correctly. - While you are playing a disc, set the AV IN/DVD switch to DVD mode - While you are viewing video from other equipment, set the AV IN/DVD switch to AV IN mode.
	• LCD mode is set to OFF.	• Select a LCD mode other than OFF.
	• Check that Brightness control is set to “-”.	• Adjust the brightness.
	• The TV is not set to receive DVD signal output.	• Select the appropriate video input mode on the TV so the picture from the DVD player appears on the screen.
No sound.	• The equipment connected with the audio cable is not set to receive DVD signal output.	• Select the correct input mode of the audio receiver so you can listen to the sound from the DVD player.
	• The audio cables are not connected securely.	• Connect the audio cable into the jacks securely.
The DVD player does not start playback.	• An unplayable disc is inserted.	• Insert a playable disc. (Check the disc type, color system and Regional code.)
	• The Rating level is set.	• Cancel the Rating function or change the rating level.
No response when buttons are pressed.	• Some discs prohibit certain operations.	• “⊗” may appear on the screen during operation.
The Remote Control does not work properly.	• The Remote Control is too far from the DVD player.	• Operate the Remote Control within about 23 ft (7 m).

Specifications

DVD Player

Power supply:

DC 9.5V (AC adapter terminal), DC 7.4V (Battery)

Power consumption: 12W with battery

Weight: 1.6 lbs (0.74 kg) (without battery pack)

External dimensions (W x H x D):

7.5 x 6.8 x 1.5 inches (191 x 174 x 39 mm)

Signal system: PAL

Laser:

DVD Laser wavelength 662+25 / 662-15 nm

CD Laser wavelength 785+25 / 785-15 nm

Frequency range (audio):

DVD linear sound: 48kHz sampling 8 Hz to 20 kHz

96kHz sampling 8 Hz to 44 kHz

Signal-to-noise ratio (audio): More than 85 dB

Dynamic range (audio): More than 95 dB

Harmonic distortion (audio): 0.008 %

Operating conditions:

Temperature: 0°C to 40°C, Operation status: Horizontal

Connectors

Video input/output (VIDEO In/Out):

1.0 V (p-p), 75 Ω, negative sync., ø3.5mm mini jack x 1

Audio input/output (AUDIO In/Out, analog audio):

1.6 Vrms(1 KHz, 0 dB), ø3.5mm mini jack x 1

Earphone terminal: ø3.5mm stereo mini jack x 2

Liquid Crystal Display

Panel size: 7 inches wide (diagonal)

Projection system: R.G.B. stripe

Driving system: TFT active matrix

Resolution: 234 x 480 x 3 (effective pixel rate: more than 99.99%)

Supplied Accessories

- RCA Audio/Video cable 1
- AC Adapter (DP-AC90) 1
- Automotive Adapter (DPDC1) 1
- Battery Pack (DPB130) 1
- Remote control 1
- Battery for Remote control (Lithium Battery) 1

- Design and specifications are subject to change without notice.

